

Zubehör

Accessoires

Accessori

Accessory

Anschlagschraube AS

Vis d'arrêt AS

Vite d'arresto AS

Adjusting stop screw AS

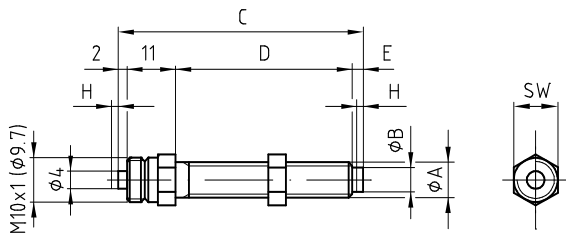

Typ	AS 08/15	AS 08/25	AS 08/40	AS 08/60	AS 08/80	AS 12/60	AS 12/80
Art.No.	4000093	4000094	4000095	4000096	4000097	4000098	4000099
H mm	1.5	1.5	1.5	1.5	1.5	1.5	1.5
øA mm	M8x1	M8x1	M8x1	M8x1	M8x1	M12x1	M12x1
øB mm	5.5	5.5	5.5	5.5	5.5	8	8
C mm	30	40	55	75	95	76	96
D mm	15	25	40	60	80	60	80
E mm	2	2	2	2	2	3	3
SW mm	10	10	10	10	10	12	12

Initiatorhalter IH ø6.5

Appui de détecteur IH ø6.5

Supporto micro IH ø6.5

Proximity switch holder IH ø6.5

4000100

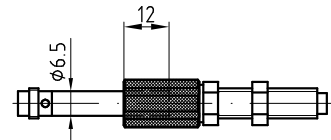
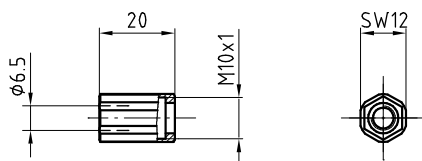

Initiatorhalter IH M8x1

Appui de détecteur IH M8x1

Supporto micro IH M8x1

Proximity switch holder IH M8x1

4000101

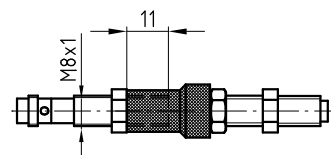
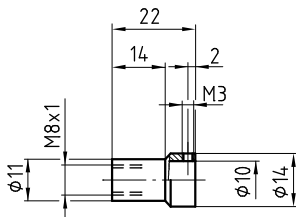

Initiator-Spannmutter ISM 6.5

Appui de détecteur ISM ø6.5

Supporto micro ISM ø6.5

Proximity switch holder ISM ø6.5

4000102

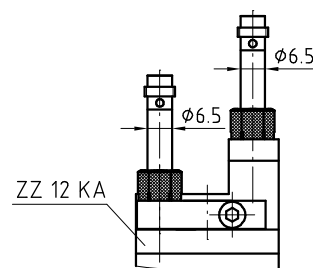
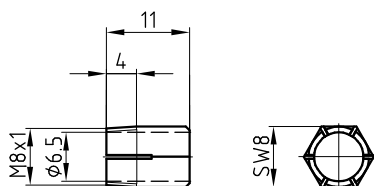

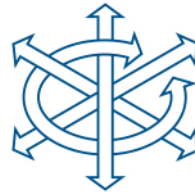

Zubehör

Accessoires

Accessori

Accessory

Winkel-Initiatorhalter WIH ø6.5	Appui de détecteur coudé WIH ø6.5	Supporto micro angolare WIH ø6.5	Proximity switch holder angled WIH ø6.5	4000103
---------------------------------	-----------------------------------	----------------------------------	---	---------

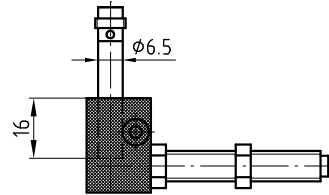
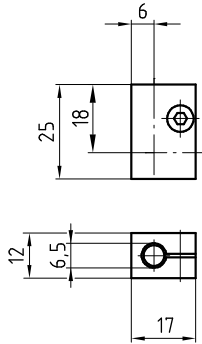

Winkel-Initiatorhalter WIH M8x1	Appui de détecteur coudé WIH M8x1	Supporto micro angolare WIH M8x1	Proximity switch holder angled WIH M8x1	4000104
---------------------------------	-----------------------------------	----------------------------------	---	---------

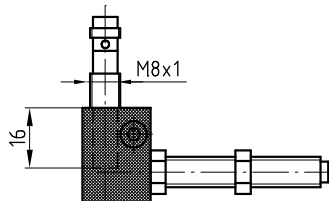
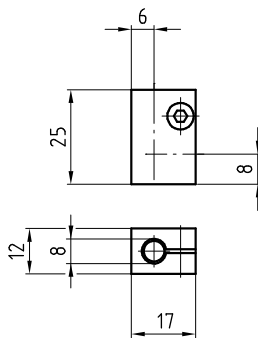

Winkel-Initiatorhalter 8x8 rechts	Appui de détecteur coudé 8x8 droite	Supporto micro angolare 8x8 destro	Proximity switch holder angled 8x8 right	4000105
-----------------------------------	-------------------------------------	------------------------------------	--	---------

Winkel-Initiatorhalter 8x8 links	Appui de détecteur coudé 8x8 gauche	Supporto micro angolare 8x8 sinistro	Proximity switch holder angled 8x8 left	4000106
----------------------------------	-------------------------------------	--------------------------------------	---	---------

Lieferumfang: 2 Schrauben M3x8	Matériel livré: 2 Vis M3x8	Ambito di fornitura: 2 Viti M3x8	Items supplied: 2 screws M3x8
--	--------------------------------------	--	---

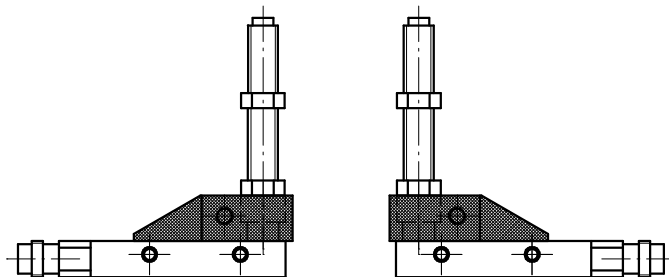
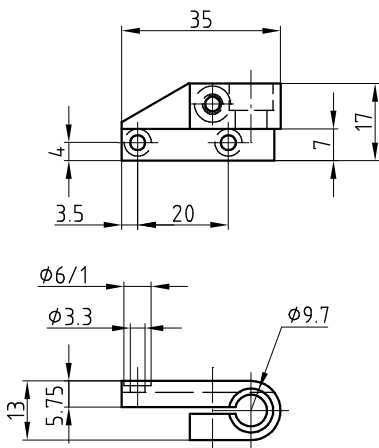

rechts
droite
destro
right

links
gauche
sinistro
left

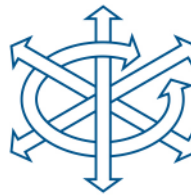

Zubehör

Accessoires

Accessori

Accessory

Initiator 6.5 LED	Détecteur 6.5 LED	Micro 6.5 LED	Proximity switch 6.5 LED	PNP	NPN
Artikelnummer	No d'article	Codice No.	Reference No.	80900001	80900002



Initiator M8x1 LED	Détecteur M8x1 LED	Micro M8x1 LED	Proximity switch M8x1 LED	PNP	NPN
Artikelnummer	No d'article	Codice No.	Reference No.	80900003	80900004

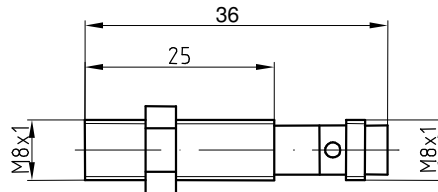

Initiator 8x8 LED	Détecteur 8x8 LED	Micro 8x8 LED	Proximity switch 8x8 LED	PNP	NPN
Artikelnummer	No d'article	Codice No.	Reference No.	80900005	80900006

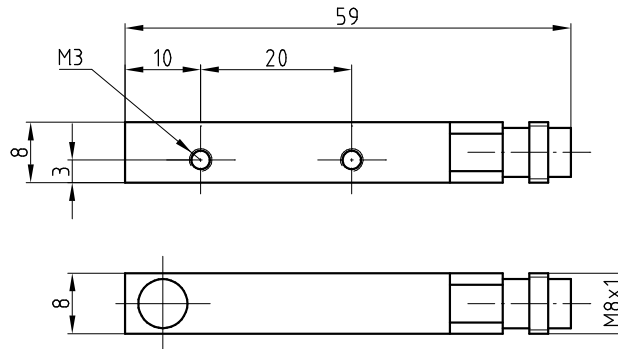

Kabel mit Stecker	Câble avec prise	Cavo con spina	Cable with plug	Type A	Type B
Artikelnummer	No d'article	Codice No.	Reference No.	80900007	80900008

Type A

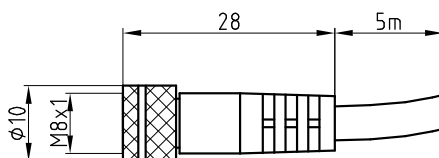

Type B

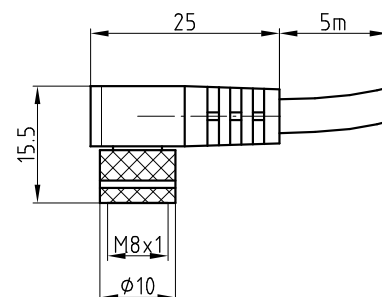

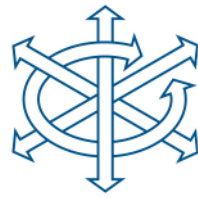

Zubehör

Accessoires

Accessori

Accessory

6kt-Mutter

Ecrou six pans

Dado esagonale

Hexagonal nut

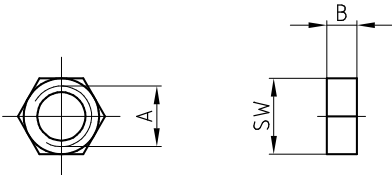

Typ	M8x1	M10x1	M12x1	M14x1
Art.No.	4000107	4000108	4000109	4000110
SW	10 mm	12 mm	14 mm	16 mm
A	M8x1	M10x1	M12x1	M14x1
B	4 mm	4 mm	4 mm	4 mm

Positionierringe

Baque de positionnement

Anello di posizionamento

Positioning ring

4000111

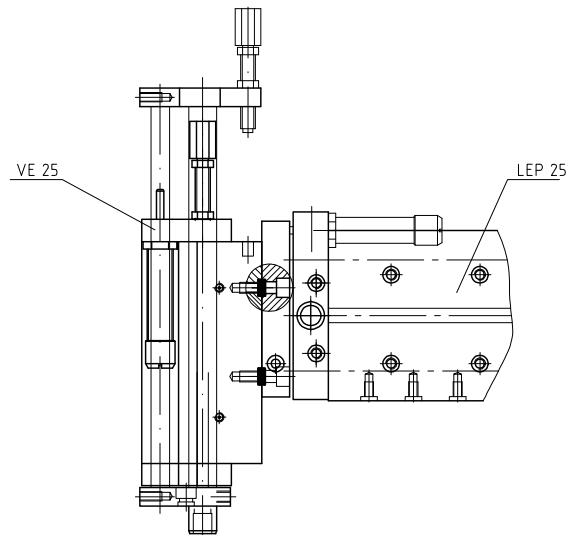
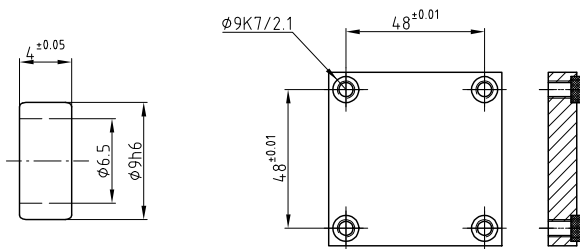

Positionierstift

Goupille de positionnement

Perno di posizionamento

Positioning pin

4000112

